

DENSELIGHT SEMICONDUCTORS PTE. LTD.
6 Changi North St. 2, S498831 SINGAPORE
Tel: (65) 64154488
Fax: (65) 64157988
www.denselight.com

SPECIFICATIONS

1310 nm High Power Superluminescent LED

DL-CS3404A

DenseLight Semiconductors reserves the right to make product design or specifications changes without notice.

A. PRODUCT DESCRIPTION

The DenseLight DL-CS3404A series is a broadband SLED that operates in a true inherent superluminescent mode. This superluminescent property generates broader band at higher drive currents in contrast to other conventional SLEDs which are ASE-based, where high drive tends to give narrower band. Its low coherence reduces Rayleigh backscattering noise. Coupled with high power and large spectral width, it offsets photoreceiver noise and improves spatial resolution (in OCT) and measurand sensitivity (in sensors). The SLED is available in 14-pin BTF package. It is compliance with the requirements of Bellcore Document GR-468-CORE.

Enabled by DensePIC™ spread spectra bandgap engineering technology, future generations of DenseLight SLEDs promise higher chip powers (up to 50mW possible), and broader spectral bands (beyond 120nm). Higher levels of integration may feature integrated SLEDs with phase modulators, optical couplers and photodetectors into a complete optical sensor chipset.

For responsive prototyping enquiries please email: info@denselight.com

B. FEATURES

- Ex-fiber output power > 40mW
- 3dB bandwidth of >40nm
- Spectral modulation of <0.5dB
- 14-pin BTF package
- SM fiber

C. APPLICATIONS

- Fiber Optic Gyroscope
- Optical Test Instrument
- Fiber Optic Sensors
- Fiber Optic Communications
- Optical Coherence Tomography
- Biomedical Imaging Device
- Clinical Healing Equipment

D. ABSOLUTE MAXIMUM RATINGS

Parameter	Symbol	Condition	Min	Max	Unit
Reverse voltage	V_R			2	V
Forward current	I_F			750	mA
Forward voltage	V_F	I_{op}		3	V
Case temperature	T_C	I_{op}	-20	55	°C
SLED temperature ¹	T_{SLED}	I_{op}	0	70	°C
Thermoelectric cooler voltage	V_{TEC}			3.56	V
Thermoelectric cooler current	I_{TEC}			2.6	A
Storage temperature	T_{stg}	Unbiased	-40	85	°C
Storage humidity			5	85	%RH
Electro static discharge (ESD)	V_{ESD}	Human body model		500	V
Lead soldering temperature	S_{temp}			260	°C
Lead soldering time	S_{time}			10	sec

E. SPECIFICATIONS ($T_{SLED} = 25\text{ °C}$)

Parameter	Symbol	Condition	Min	Typ	Max	Unit
Operating current	I_{op}				700	mA
Forward voltage	V_F	I_{op}			2.4	V
Power in SMF	P_o	I_{op}	40			mW
Central wavelength	λ	I_{op}	1290	1310	1330	nm
Bandwidth	B_{FWHM}	I_{op}	40			nm
Spectrum modulation ²	R	I_{op}			0.5	dB
Thermistor resistance	R_{therm}	$T = 25\text{ °C}$	9.5	10	10.5	k Ω
Thermoelectric cooler voltage	V_{TEC}	I_{op}			3.0	V
Thermoelectric cooler current	I_{TEC}	I_{op}			1.8	A

1. T_{SLED} is monitored by internal thermistor with external pin out.
2. Peak-to-peak modulation shall be measured at the range of +/- 2.5nm of peak wavelength. Spectrum modulation will be measured at resolution of 0.1nm.

F. PACKAGE

BTF package

Part	Description
Package type	BTF
Fiber:	SMF-28
MFD	9 μ m
Cladding diameter	125 μ m
Coating diameter	245 μ m
Jacket	900 μ m loose tube
Fiber pigtail length	1m
Fiber bending radius	>40mm
Connector	FC/APC
Dimensions	See figure

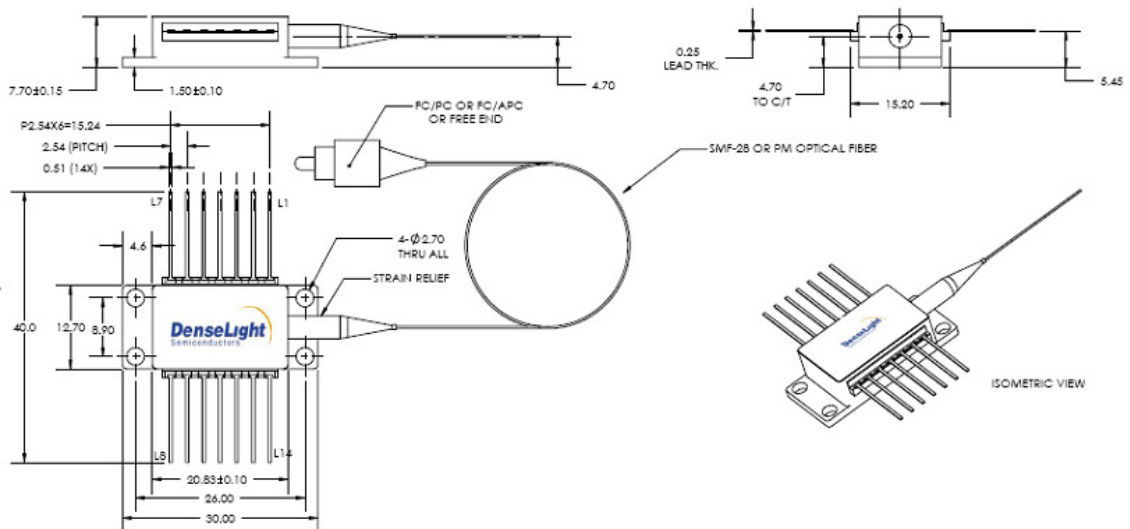

Pin Assignment	
1	TEC+
2	THERMISTOR
3	-
4	-
5	THERMISTOR
6	-
7	-
8	-
9	-
10	SLED ANODE +
11	SLED CATHODE -
12	-
13	CASE
14	TEC -

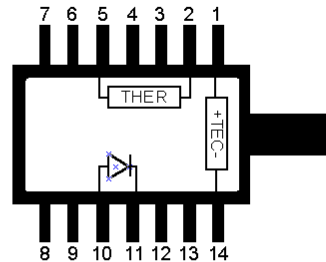

G. TYPICAL PERFORMANCE CHARACTERISTICS

Operating condition: $T_{SLED} = 25\text{ }^{\circ}\text{C}$

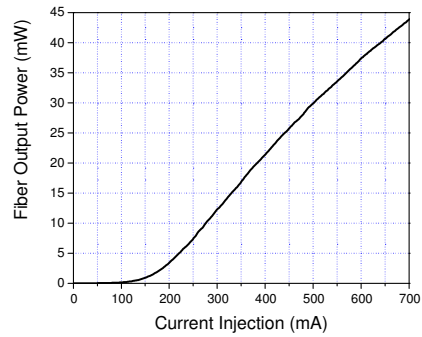

P-I Curve

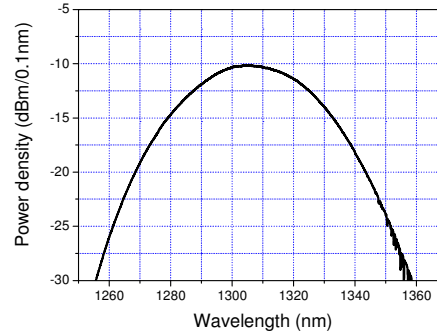

Spontaneous Emission Spectrum

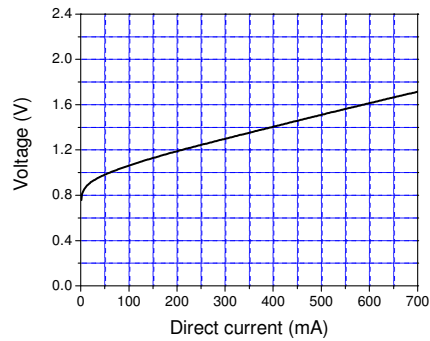

I-V Curve

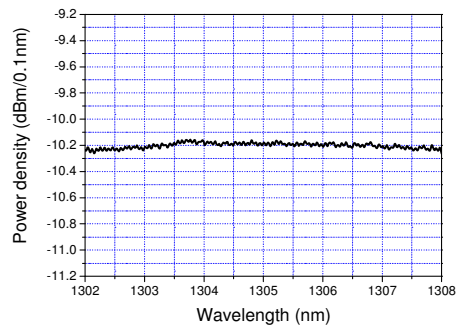

Spectrum Modulation