



The ModBox-1310nm-1550nm-28Gbaud-PAM4 is a dual wavelength 1310 nm and 1550 nm Linear Reference Transmitter that generates excellent quality optical data streams PAM-4 up to 28 Gbaud and NRZ up to 28 Gb/s. The transmitter produces very clean eye diagrams with high SNR and fast rise and fall times. It also provides the flexibility of adjusting the extinction ratio for vertical eye closure.

The ModBox-1310nm-1550nm-28Gbaud-PAM4 provides R&D and Production engineers with a user friendly turn-key instrument delivering state of the art performance. It is being used in optical telecommunications laboratories and production test beds.

The equipment incorporates a modulation stage based on a chirp-free LiNbO₃ Mach-Zehnder modulator, coupled with a high performance RF driver and an automatic bias control circuitry. The ModBox integrates two DFB lasers centered at 1310 nm and 1550 nm.

In addition to the dual wavelength, ixblue offers reference transmitters in the full O-band, full C-band and at 850 nm.

FEATURES

- 1310nm & 1550nm Reference Transmitter
- PAM-4 up to 28 Gbaud
- NRZ up to 28 Gb/s
- 1310nm & 1550nm lasers embedded
- Reliable & reproducible measurements
- High eye diagram stability
- Extinction Ratio Adjustable

APPLICATIONS

- Transmission system test
- Components characterization
- Production test
- R&D laboratories

OPTIONS

- Tunable C-band laser
- Multi-Channel
- 850 nm, O-band, C-band

Performance Highlights

Parameter	Min	Typ	Max
Operating wavelength	1310 nm & 1550 nm		
Modulation format	PAM-4, NRZ		
Modulation bandwidth	PAM-4 up to 28 Gbaud, NRZ up to 28 Gb/s		
Modulated output power @1310 nm	2 dBm	3 dBm	-
Modulated output power @1550 nm	5 dBm	6 dBm	-

Functional Block Diagram

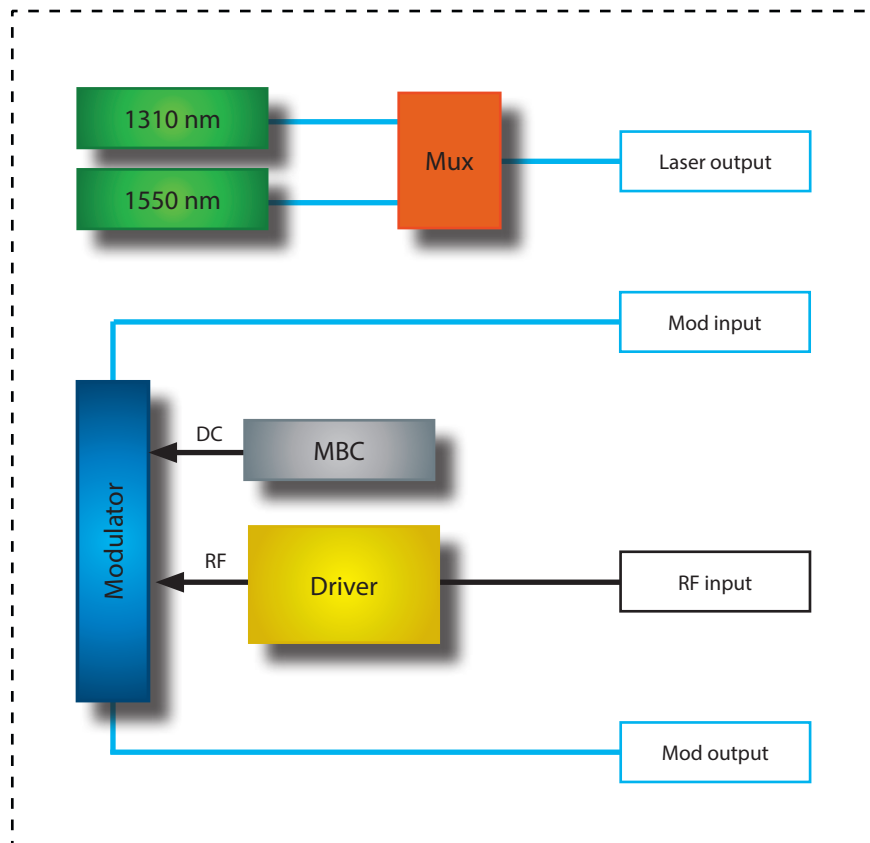

The ModBox-1310nm-1550nm-28Gbaud-PAM4 features:

- A chirp-free X-cut LiNbO₃ (Lithium Niobate) Mach-Zehnder Intensity modulator. It is selected for its wide optical bandwidth, and its high electro-optic bandwidth and flat, low ripple, electro-optic response curve.
- A high bandwidth and highly linear RF driver.
- A modulator bias controller. The internal LiNbO₃ modulator is a X-cut device with very low drift. However an automatic bias control circuit is provided to lock the operating point of the modulator at the quadrature point whatever the environmental and optical (laser power and wavelength) conditions. The MBC ensures a highly stable optical output signal to provide reliable and reproducible measurements.
- Two 1310 nm and 1550 nm low RIN lasers are integrated by default (C-Band tunable laser in option). For convenience, the two lasers are multiplexed and an external patch cord is delivered to connect the laser output to the modulator input optical port. Wavelength selection (1310 nm or 1550 nm) and laser power are tunable through the front panel controls or the ModBox software interface.

The ModBox-1310nm-1550nm-28Gbaud-PAM4 is controlled from the front panel via the Smart interface with a simple rotary knob and keypad. The Smart manual interface allows for bias control circuit, RF driver and laser settings. It comes also with a simple GUI solution, Windows based and implemented through the USB interface of the user PC.

Input Electrical Specifications User supplied, not a ModBox specification

Parameter	Symbol	Condition	Min	Typ	Max	Unit
Data-rate	PRBS	PAM-4 electrical input signal	0.1	-	28	Gbaud
		NRZ electrical input signal	0.1	-	28	Gb/s
Input voltage	V_{IN}	AC coupled - 50 Ω - Linear operation	-	0.200	0.300	Vpp
Jitter	J_{RMS}	-	-	1	1.2	ps
Rise / fall time	t_r / t_f	20 % - 80 %	-	13	18	ps
Corss-point	-	NRZ mode	45	50	55	%

Input Optical Specifications User supplied, not a ModBox specification

Parameter	Symbol	Condition	Min	Typ	Max	Unit
Operation	λ	CW	1310	1550	1565	nm
Polarization	-	-	Linear and controlled			-
Power	P	1310 nm / 1550 nm	-	10 / 16	-	dBm
Side Mode Supression Ratio	SMSR	-	30	-	-	dB
Spectrum linewidth	$\Delta\lambda$	FWHM	-	0.5	1	MHz
Polarization Extinction ratio	PER	-	-	19	-	dB

Output Optical Specifications Specifications below are given with embedded 1310 nm and 1550 nm lasers.

Parameter	Symbol	Condition	Min	Typ	Max	Unit
Embedded Laser	λ	DFB integrated by default	1310 nm & 1550 nm			-
Data format	-	-	PAM-4 & NRZ			-
Data-rate	-	PAM-4 electrical input signal	0.1	-	28	Gbaud
		NRZ electrical input signal	0.1	-	28	Gb/s
Output modulated power	OP_{OUT}	With embedded 1310 nm laser	2	3	-	dBm
		With embedded 1550 nm laser	5	6	-	dBm
Jitter	J_{RMS}	RMS Jitter, NRZ mode	-	0.8	-	ps
	J_{PP}	Peak-to-Peak Jitter, NRZ mode	-	5	-	ps
Minimum dynamic extinction ratio	DER_{MIN}	By NRZ data input level adjustment	2	-	-	dB
Maximum dynamic extinction ratio	DER_{MAX}	By NRZ data input level adjustment	-	10	13	dB
Dynamic Signal to Noise Ratio	SNR	NRZ mode	-	12	-	dB
Rise / fall time	t_r / t_f	NRZ mode	-	15	-	ps
Crosspoint	-	NRZ mode	45	50	55	%
Optical return loss	ORL	-	-40	-45	-	dB
Side Mode Supression Ratio	SMSR	-	30	-	-	dB
Spectrum linewidth	$\Delta\lambda$	FWHM	-	1	-	MHz

1310 nm & 1550 nm DFB Lasers Specifications The laser 1310 nm & 1550 nm lasers are embedded by default.

Parameter	Symbol	Condition	Min	Typ	Max	Unit
Lasers type	-	-	DFB			-
Wavelength	λ	Embedded by default	1310 nm & 1550 nm			-
Wavelength laser tuning range	-	Diode chip temperature control	-	0.8	1	nm
Optical output power adjustment	-	Diode Injection current control	0	-	100	%
Spectrum linewidth	$\Delta\lambda$	FWHM	1	2	-	MHz
Side Mode Suppression Ratio	SMSR	-	35	-	-	dB
Optical Return Loss	ORL	-	30	-	-	dB

Tunable C-Band Laser Specifications Option

Parameter	Symbol	Condition	Min	Typ	Max	Unit
Wavelengths laser tuning range	λ	-	1527.60	-	1565.50	nm
Optical output power	-	CW	-	15	-	dBm
Optical output power adjustment	-	Diode Injection current control	0	-	100	%
Spectrum linewidth	$\Delta\lambda$	FWHM, instantaneous	-	100	-	kHz
Side Mode Suppression Ratio	SMSR	-	40	55	-	dB
Optical Return Loss	ORL	-	30	-	-	dB

Absolute Maximum Ratings

Stresses in excess of the absolute maximum ratings can cause permanent damage to the device. These are absolute stress ratings only. Functional operation of the device is not implied at these or any other conditions in excess of those given in the operational sections of the data sheet. Exposure to absolute maximum ratings for extended periods can adversely affect device reliability.

Parameter	Symbol	Min	Max	Unit
Input voltage	V_{IN}	-	1	Vpp
Optical input power	OP_{in}	-	20	dBm

Electrical Eye Diagram

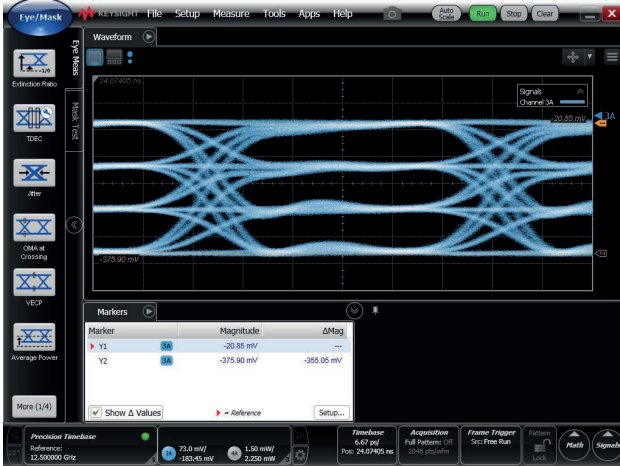

PAM-4 28 Gbaud

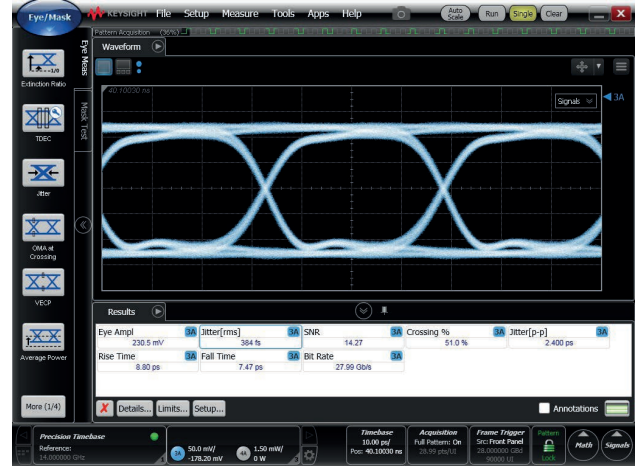

NRZ 28 Gb/s

Eye Diagrams - PAM-4 25 Gbaud From ModBox-1310nm-1550nm-28Gbaud-PAM4

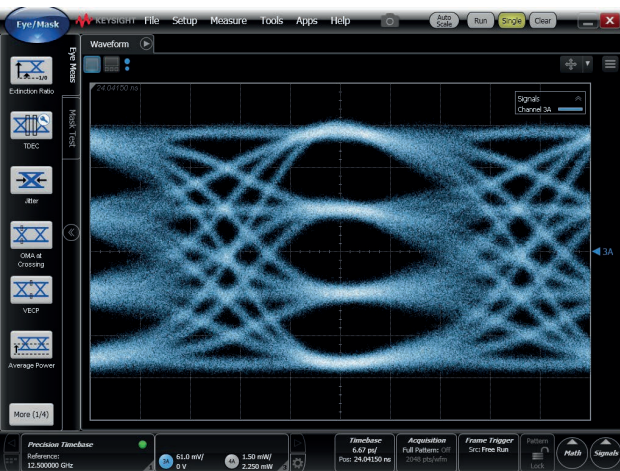

Using internal 1310 nm laser source

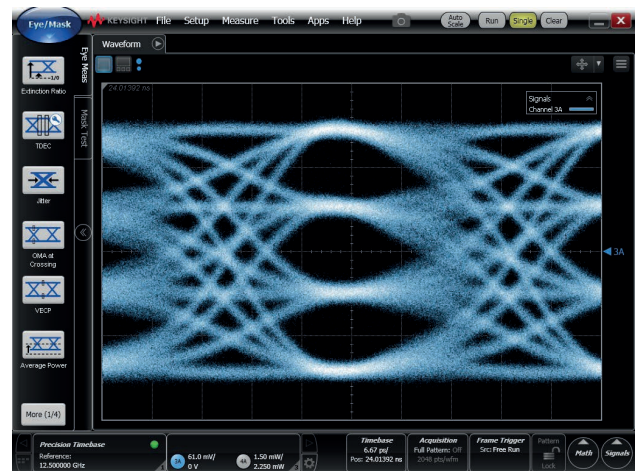

Using internal 1550 nm laser source

Eye Diagrams - NRZ 28 Gb/s From ModBox-1310nm-1550nm-28Gbaud-PAM4

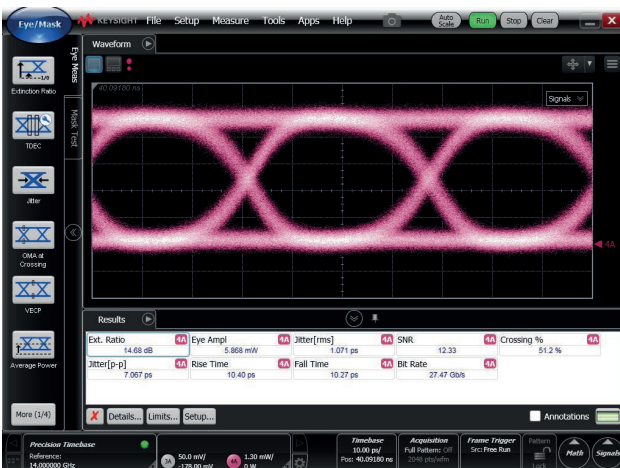

Using internal 1310 nm laser source

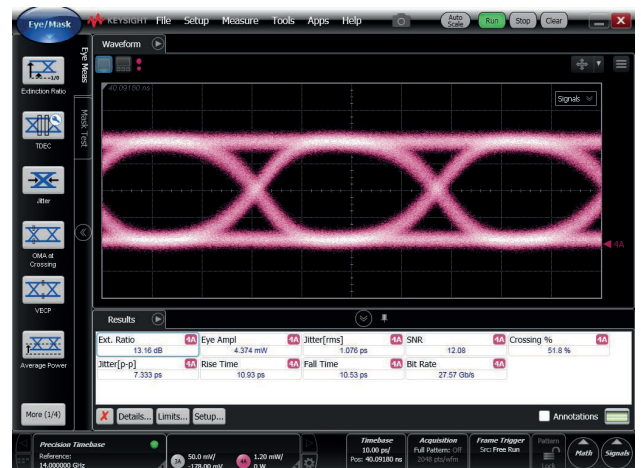

Using internal 1550 nm laser source

Interfaces, Dimensions and Compliance

Interfaces	
Optical	Polarization maintaining fiber PM - FC/APC (by default, other connectors type in option)
RF input	Single 1.85 mm female RF connector - 50 Ω
Control	Smart Interface (front panel), GUI (USB typeB)
Power supply	100-120V/220-240 automatic switch 50-60Hz (Rear panel)
EMC and optical norms	EN61326-1 Ed. 2006 / NF EN 60825-1 & EN 60825-2 Ed.2014
Dimensions / Weight	Rack 19" x 3U, Depth = 495mm / 3 kg

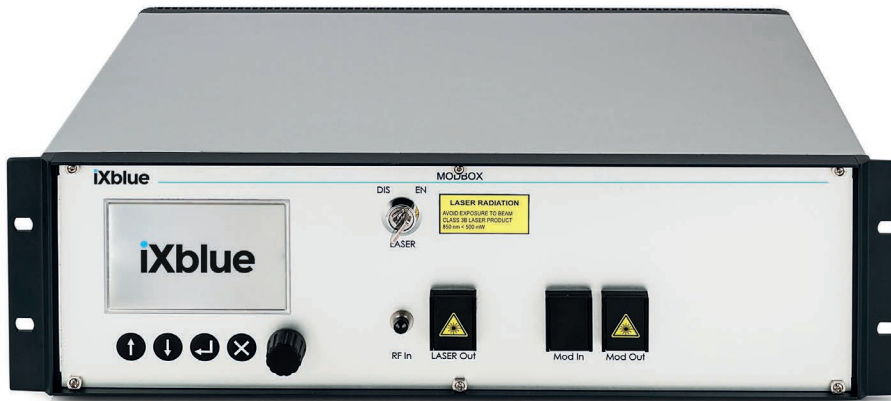

Ordering information

ModBox-1310nm-1550nm-28Gbaud-PAM4

1310nm-1550nm = 1310 nm & 1550 nm operation, embedded lasers
28Gbaud = Data-rate: NRZ up to 28 Gb/s - PAM-4 up to 28 Gbaud

Opt-TunC

TunC = Full C-Band Tunable laser
This laser comes instead of embedded DFB 1550 nm laser

Opt-YY

YY = Output connectors, FA : FC/APC - FC : FC/UPC - SA : SC/APC - SC : SC/UPC

About us

ixBlue Photonics produces specialty optical fibers and Bragg gratings based fiber optics components and provides optical modulation solutions based on the company lithium niobate (LiNbO₃) modulators and RF electronic modules.

ixBlue Photonics serves a wide range of industries: sensing and instruments, defense, telecommunications, space and fiber lasers as well as research laboratories all over the world.